

SPECIFICATION:

JOSAM SERIES FS-160 PORCELAIN COATED CAST IRON FLOOR SINK WITH 12" SQUARE TOP, 10" DEPTH, NO-HUB BOTTOM OUTLET, ALUMINUM DOME STRAINER, AND ANTI-TILT GRATE.

**FLOOR SINK
CAST IRON/PORCELAIN COAT**

SERIES **FS-160**

SLOT WIDTH: 3/8"
FREE AREA: 26 SQ. IN

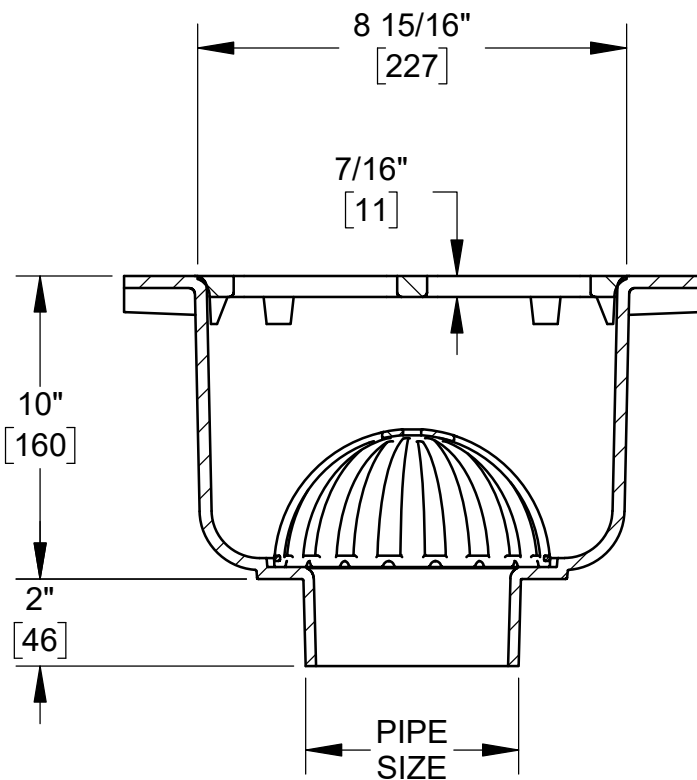
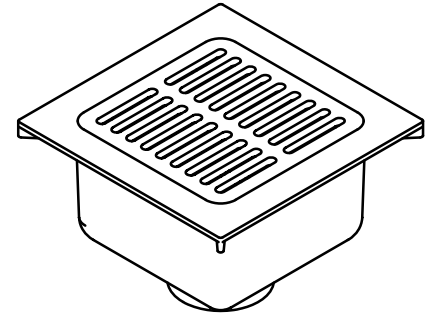
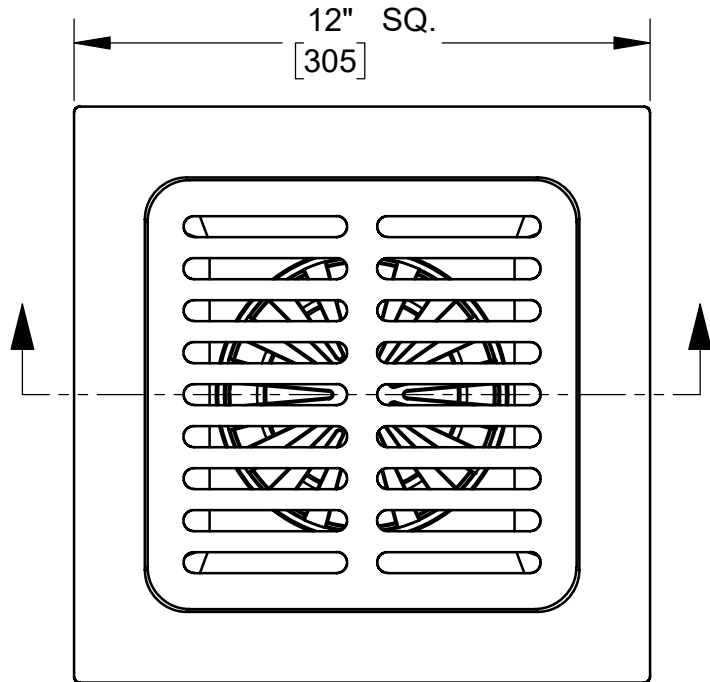

PIPE SIZE
2"
3"
4"

OPTIONS:

-LG	LESS GRATE
-3	HALF GRATE
-4	3/4 GRATE
-31	SEDIMENT BUCKET, ALUMINUM
-33	SEDIMENT BUCKET, ACID RESIST FINISH

WARNING: Cancer and Reproductive Harm - www.P65Warnings.ca.gov

DATE OF LAST CHANGE: 06/27/18

DIMENSIONS ARE SUBJECT TO MANUFACTURERS TOLERANCES AND CHANGE WITHOUT NOTICE. WE CAN ASSUME NO RESPONSIBILITY FOR USE OF SUPERSEDED OR VOID DATA.

JOSAM
MICHIGAN CITY, INDIANA

NOTES